

TELESCOPIC  
AERIAL CRANE

## POLE CAMS

Pole Cams is a modular telescopic crane, that allows a vertical moved, it is available in four different versions: 13, 6, 5 and 4 m, all versions can be equipped with Rail Pole.

It is equipped with remote head Cams 2 or 3 axes. Pole Cams can be controlled by Pan / BAR, Wheels, Bracelet and Pedal Control. Also it can be controlled the focus and zoom besides length and speed of movement of the crane sections.

Cams system has possibility to select a increase of flowing-head's movements [  $x4 - x2 - x1 - x\frac{1}{2} - x\frac{1}{4}$  ].



**DATASHEET**

Payload Max	25 kg
Weight	250 kg
Max speed	Pan/Tilt: 280°/s Excursion: 1 m/s
Arm extension	7,80 m
Operator control unit	Pan/Bar Wheels Bracelet Pedal Focus Zoom Length regulation Speed regulation
Power supply	220/115VAC
Safety system	Slowing magnets Braking magnets Mechanical limit w decelerator Emergency stop

# POLE CAMS 13 M

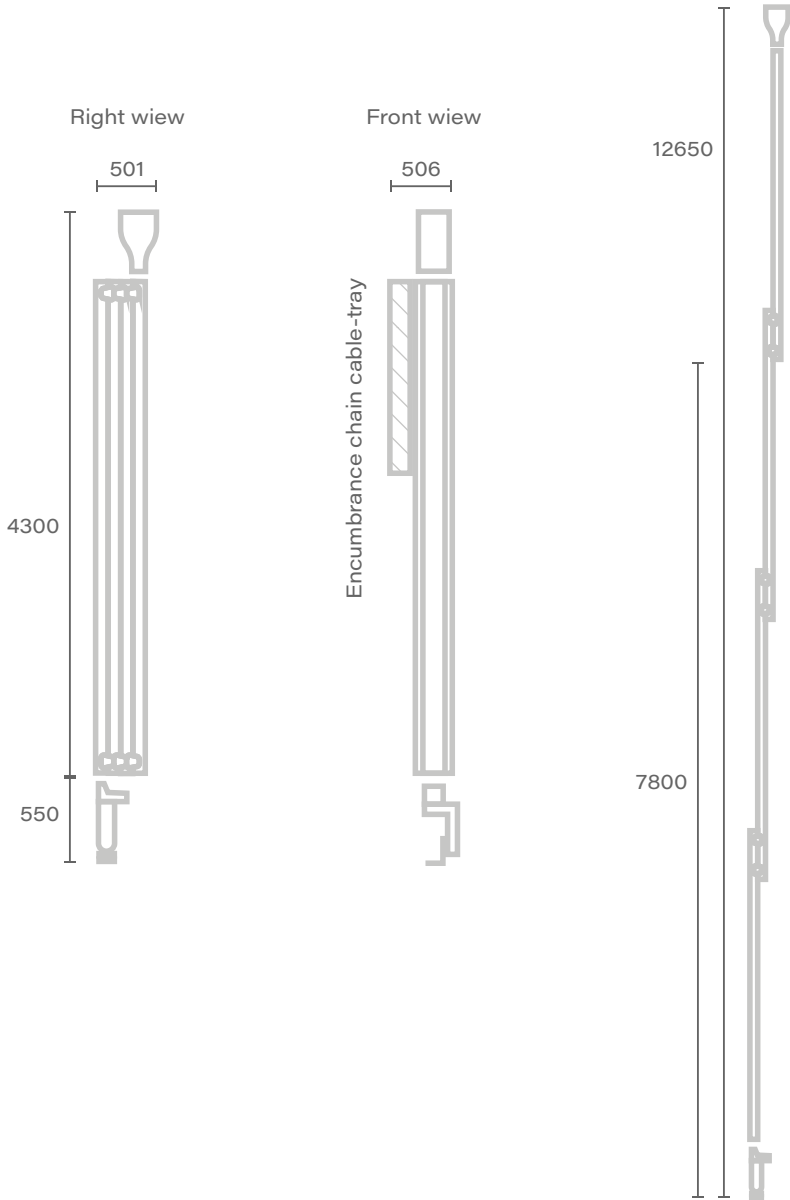

Unit of measure - millimetres [ mm ]

**DATASHEET**

---

Payload Max	25 kg
Weight	180 kg
Max speed	Pan/Tilt: 280°/s Excursion 1 m/s
Arm extension	3,60 m
Operator control unit	Pan/Bar Wheels Bracelet Pedal Focus Zoom Length regulation Speed regulation
Power supply	220/115VAC
Safety system	Slowing magnets Braking magnets Mechanical limit w decelerator Emergency stop

---

# POLE CAMS 6 M

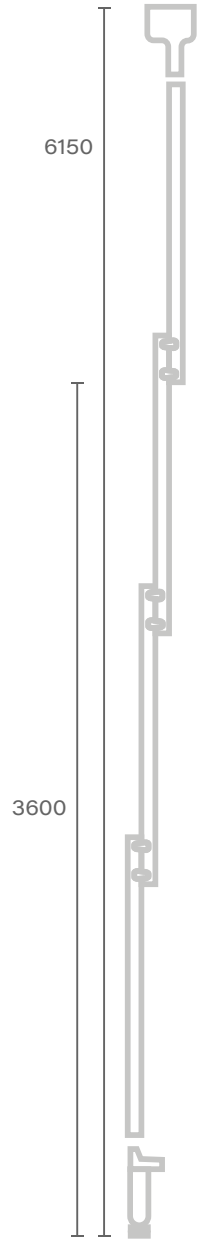
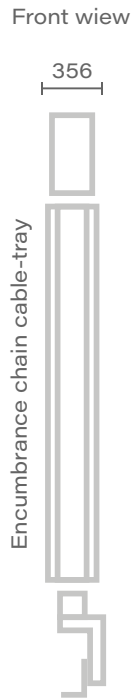
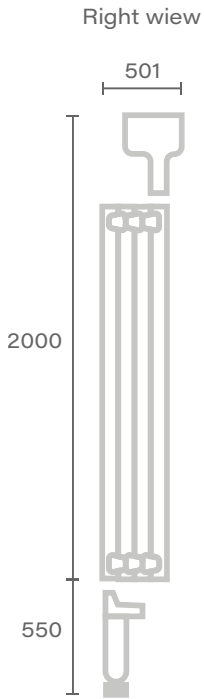

Unit of measure - millimetres [ mm ]

**DATASHEET**

---

Payload Max	25 kg
Weight	66 kg
Max speed	Pan/Tilt: 280°/s Excursion 1 m/s
Arm extension	3 m
Operator control unit	Pan/Bar Wheels Bracelet Pedal Focus Zoom Length regulation Speed regulation
Power supply	220/115VAC
Safety system	Slowing magnets Braking magnets Mechanical limit w decelerator Emergency stop

---

# POLE CAMS 5 M

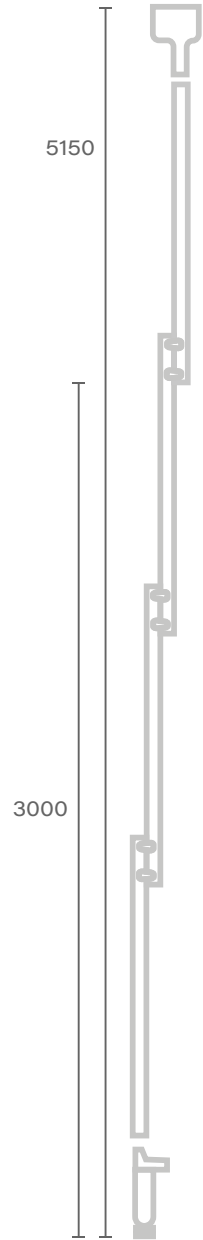
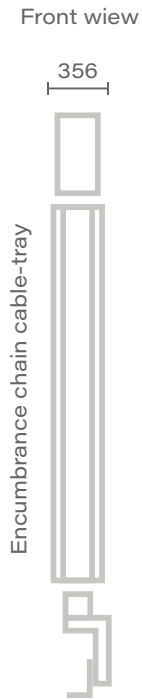
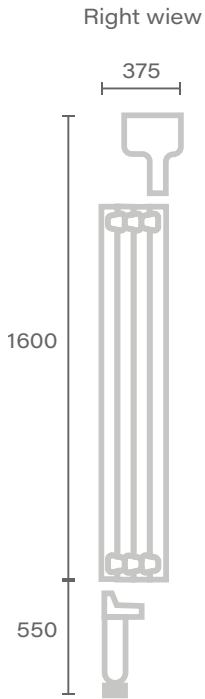

Unit of measure - millimetres [ mm ]

**DATASHEET**

---

Payload Max	25 kg
Weight	40 kg
Max speed	Pan/Tilt: 280°/s Excursion 1 m/s
Arm extension	2 m
Operator control unit	Pan/Bar Wheels Bracelet Pedal Focus Zoom Length regulation Speed regulation
Power supply	220/115VAC
Safety system	Slowing magnets Braking magnets Mechanical limit w decelerator Emergency stop

---



# POLE CAMS 4 M

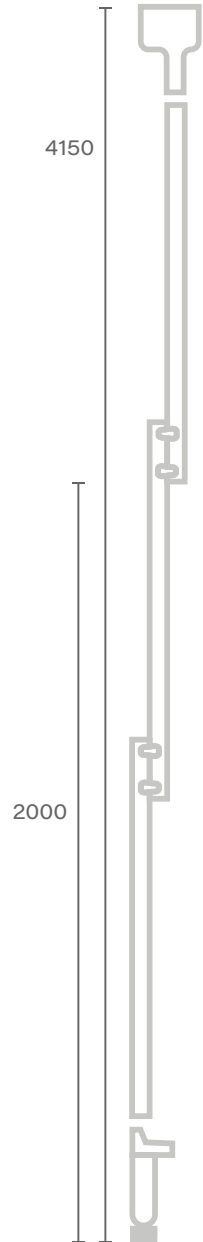
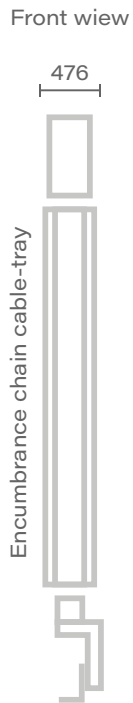
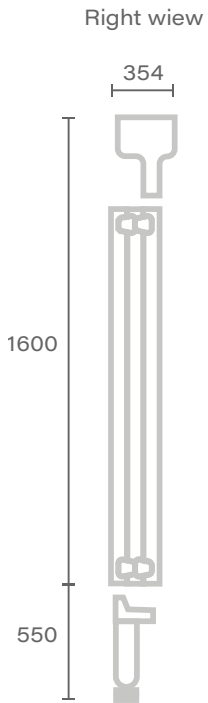

Unit of measure - millimetres [ mm ]